

KATALOG DEKORACYJNYCH
ELEMENTÓW STYROPIANOWYCH
2015

G19

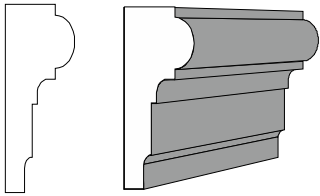

G20

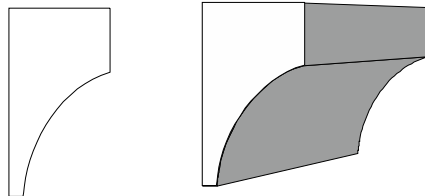

G21

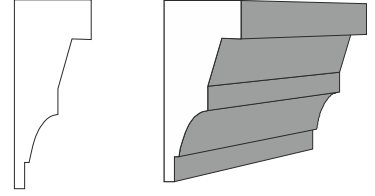

G22

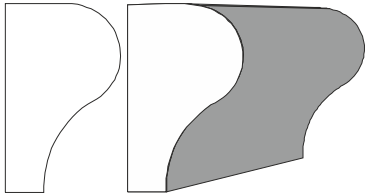

G23

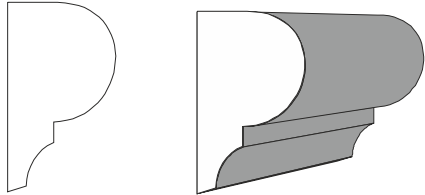

G24

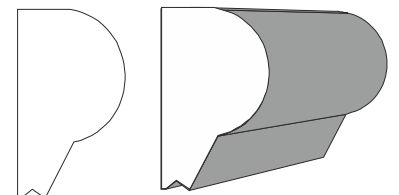

G25

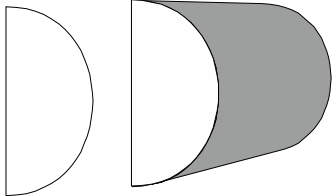

G26

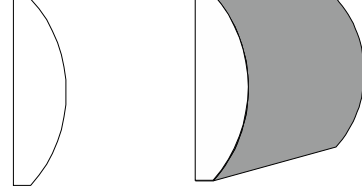

G27

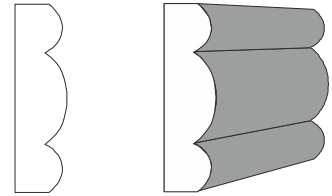

G28

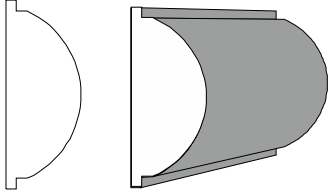

G29

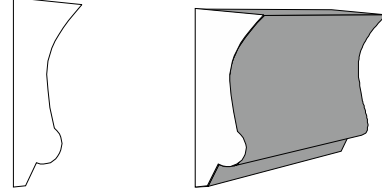

G30

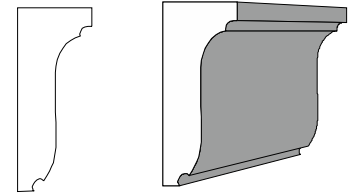

G31

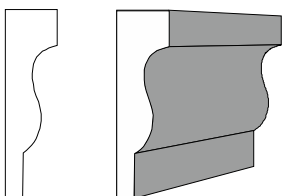

G32

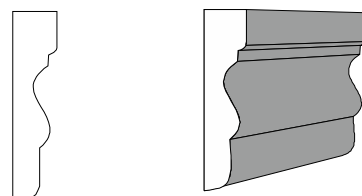

G33

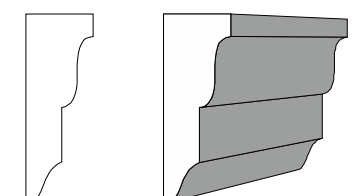

G34

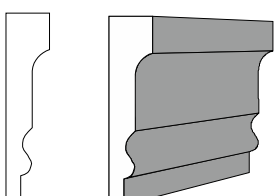

G35

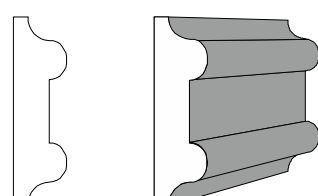

G36

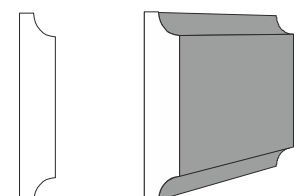

G37

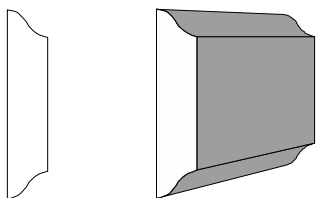

G38

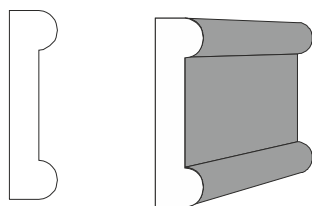

G39

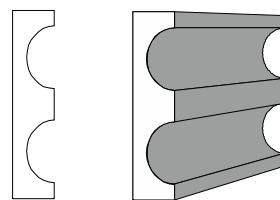

G40

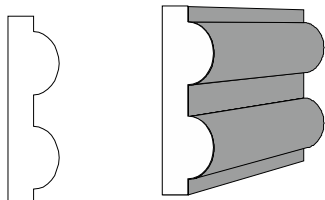

G41

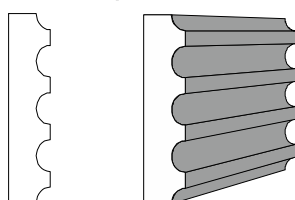

G42

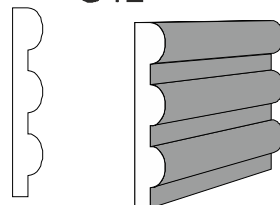

G43

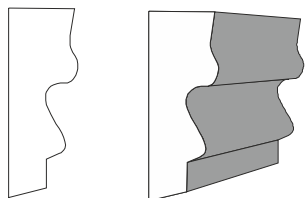

G44

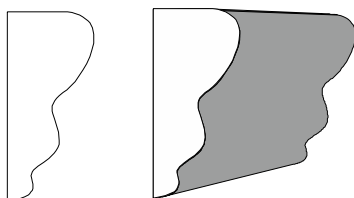

G45

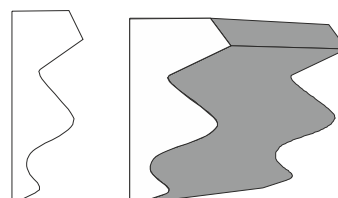

G46

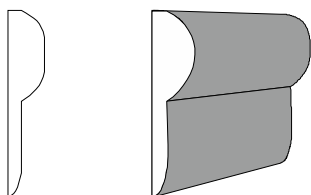

G47

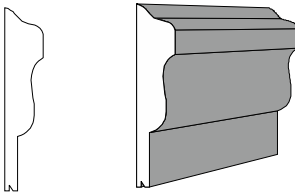

G48

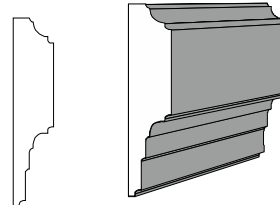

G49

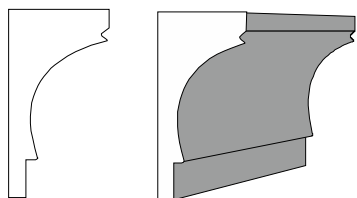

G50

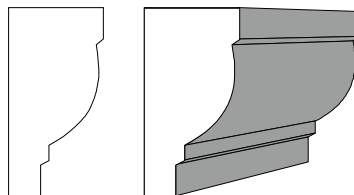

G51

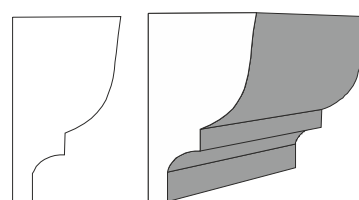

G52

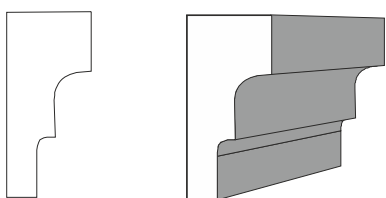

G53

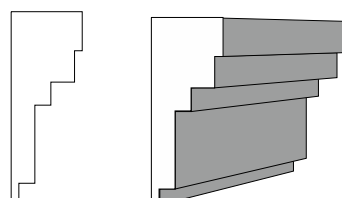

G54

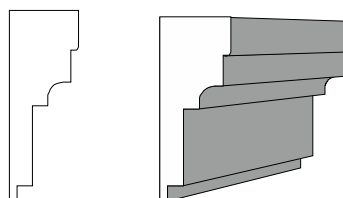

G55

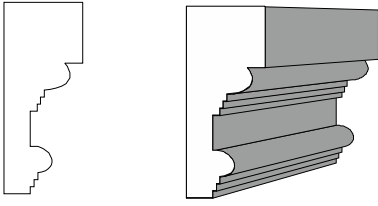

G56

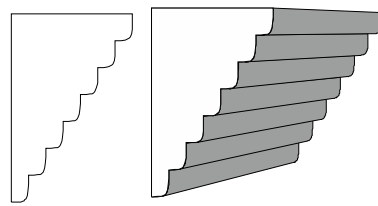

G57

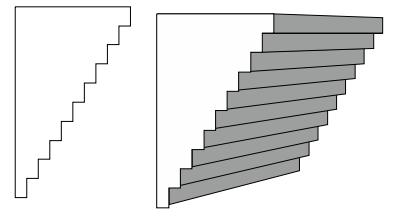

G58

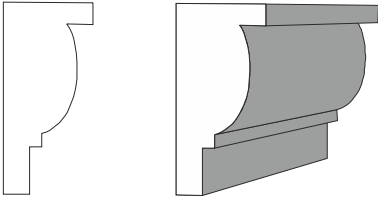

G59

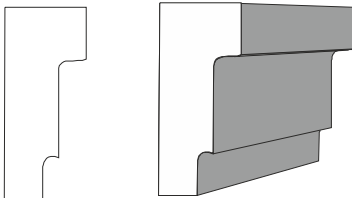

G60

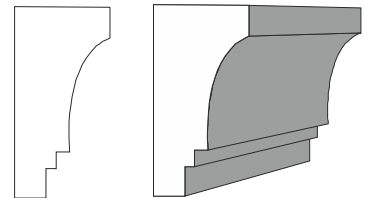

G61

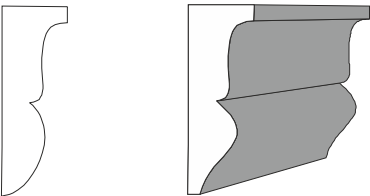

G62

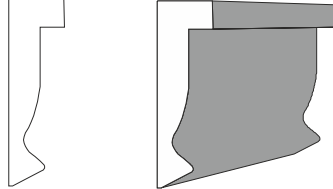

G63

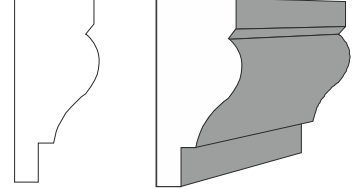

G64

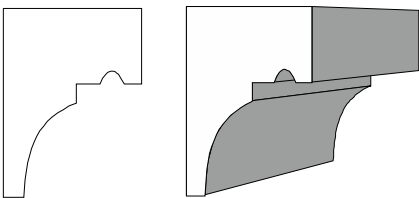

G65

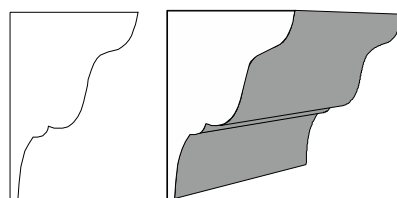

G66

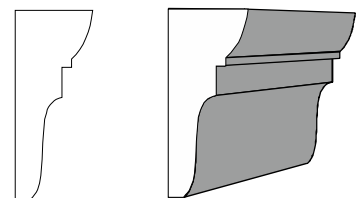

G67

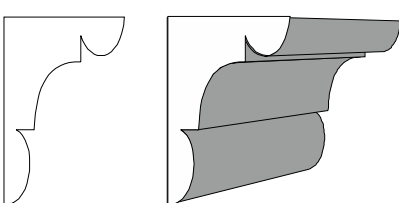

G68

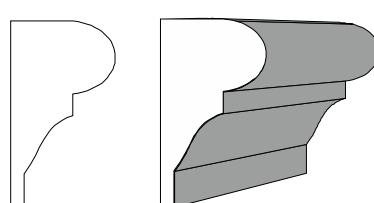

G69

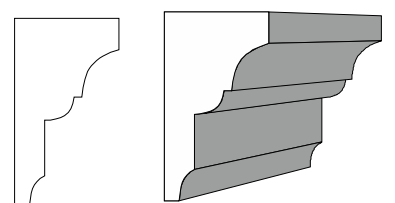

G70

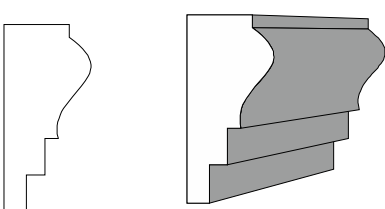

G71

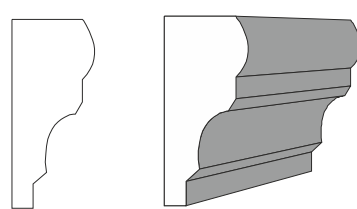

G72

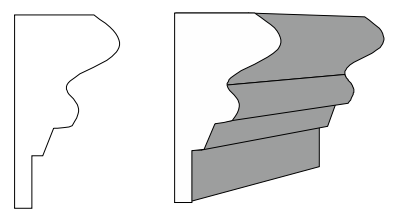

G73

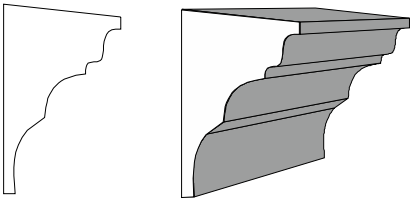

G74

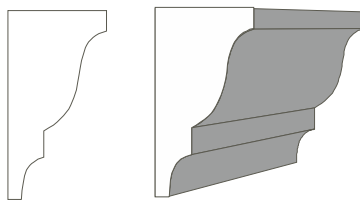

G75

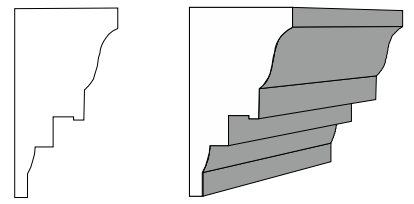

G76

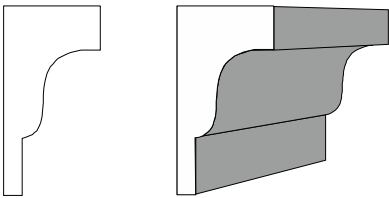

G77

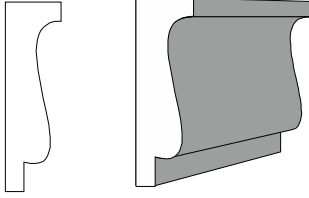

G78

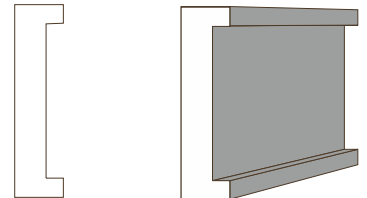

G79

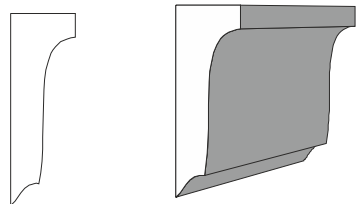

G80

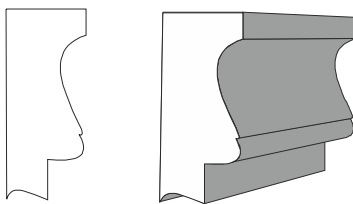

G81

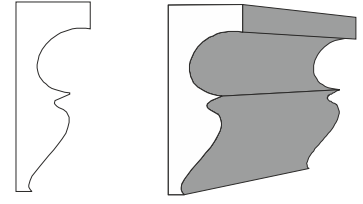

G82

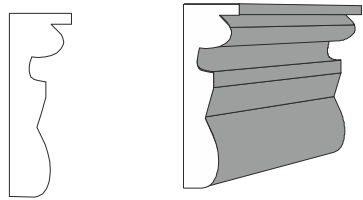

G83

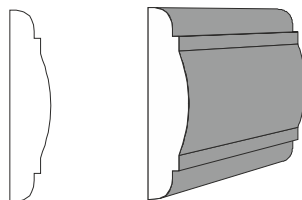

G84

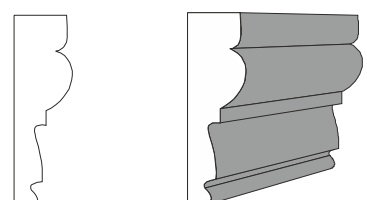

G85

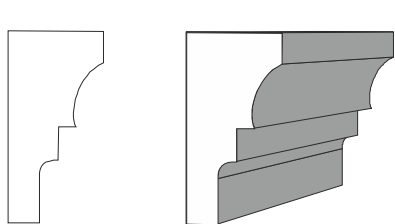

G86

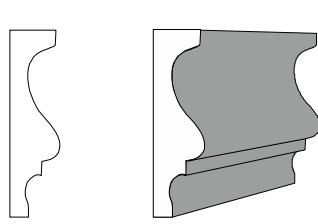

G87

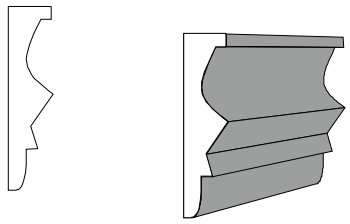

RUSTYKI

R1

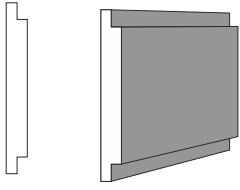

R2

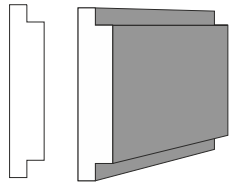

R3

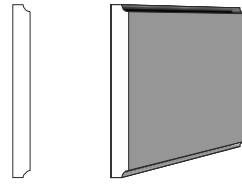

R4

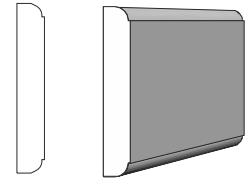

R5

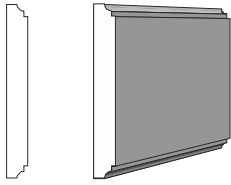

R6

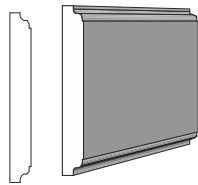

R7

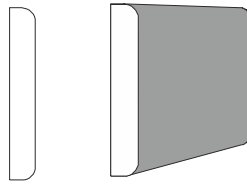

R8

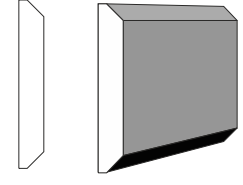

KOLUMNY

K1

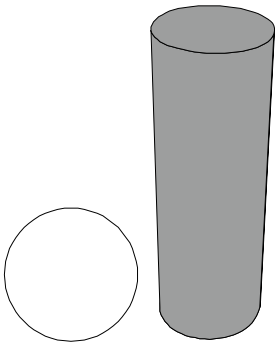

K2

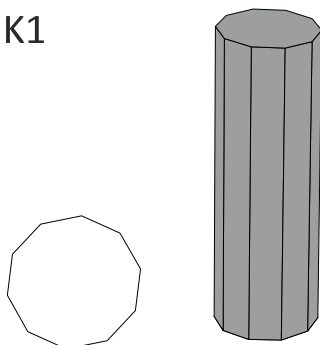

K3

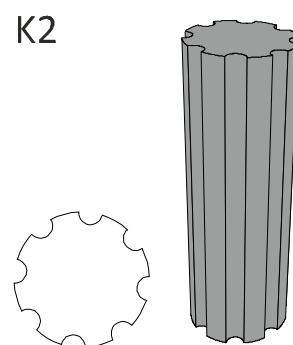

K4

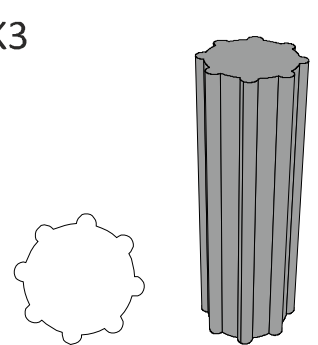

K5

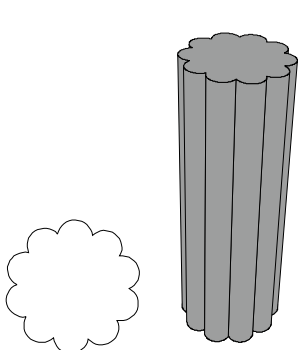

K6

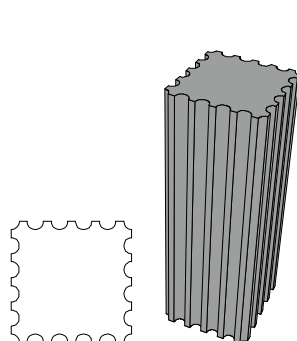

ZWORNIKI

Z1



Z2

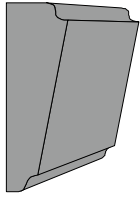

Z3



Z4

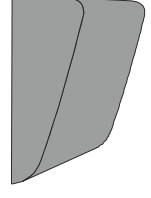
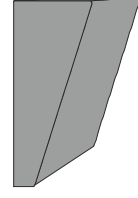
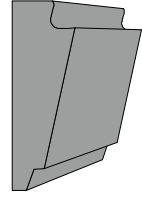
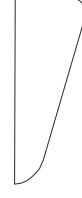

OTULINY

O1

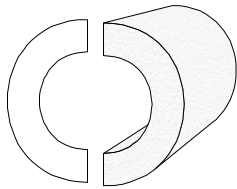

O2

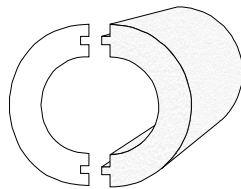

O3

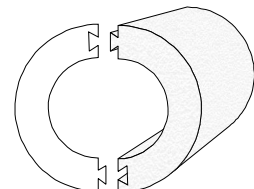

PODPARAPETNIKI

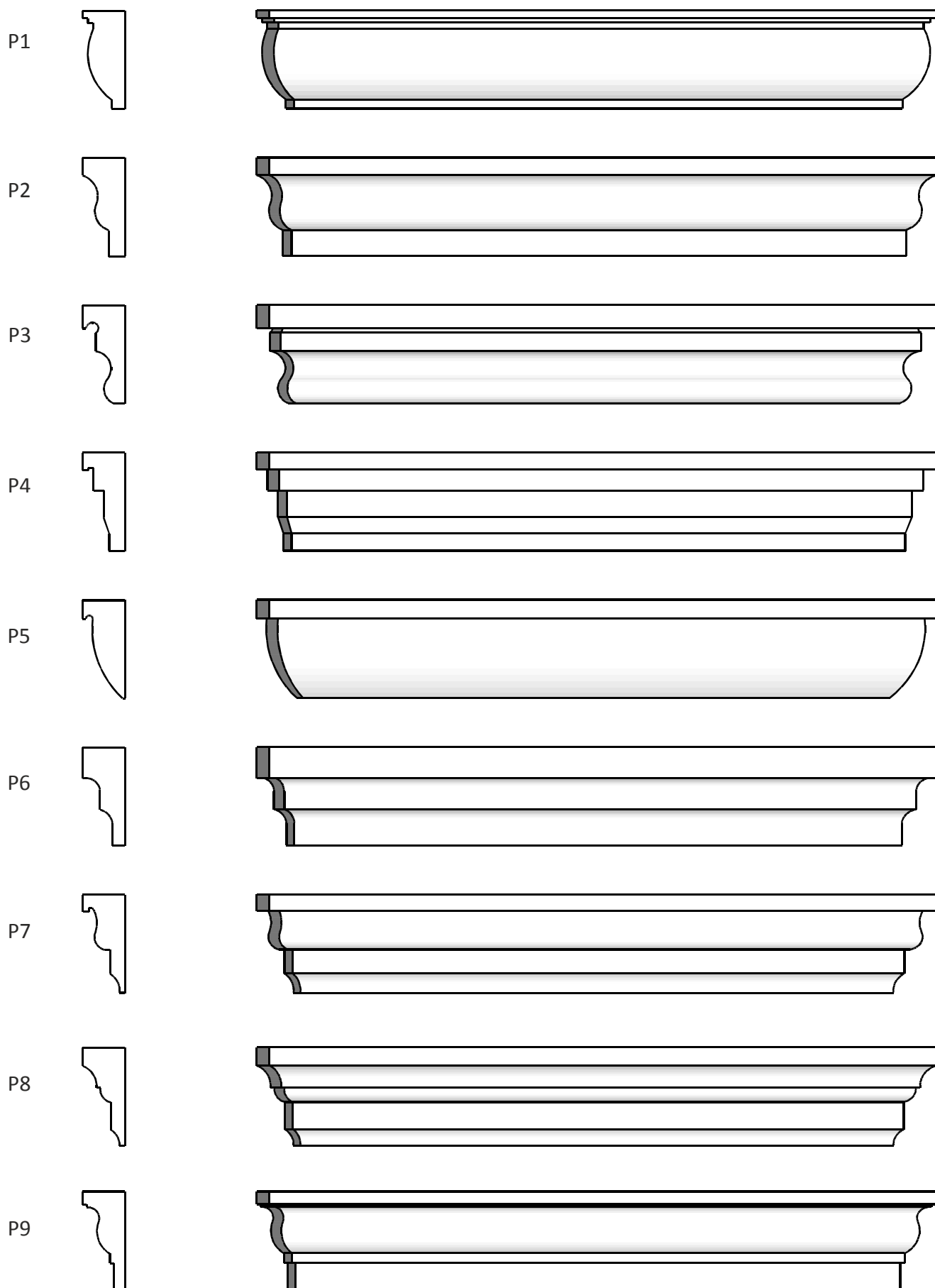

GŁOWICE I BAZY KOLUMN

GL1

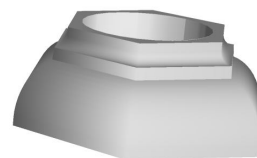
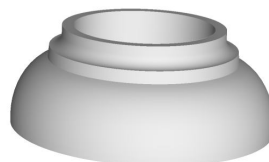
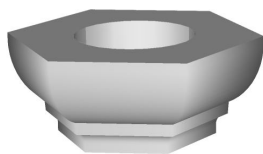
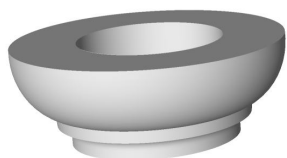
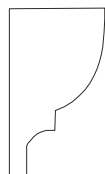

GL2

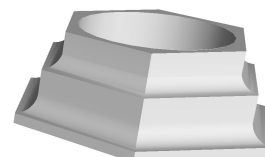
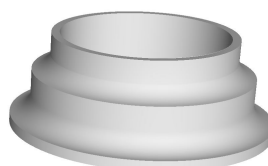
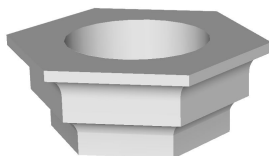
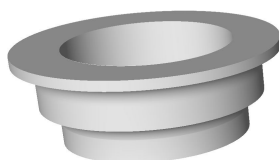
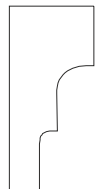

GL3

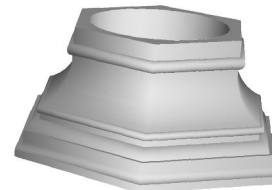
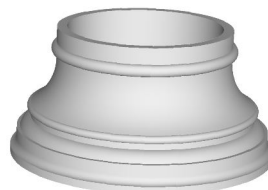
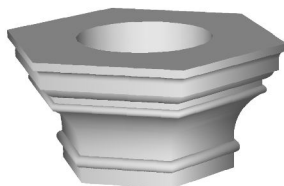
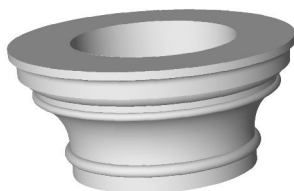

GL4

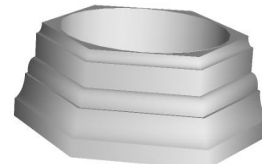
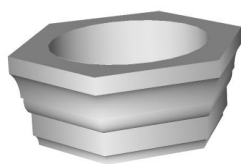
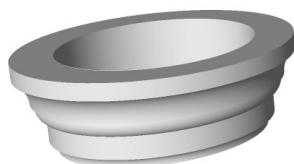

WYMIAROWANIE

GZYMSY

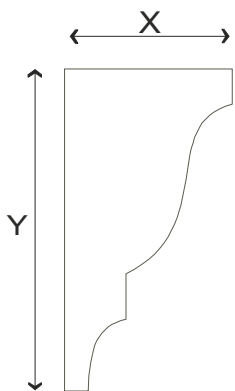

OTULINY

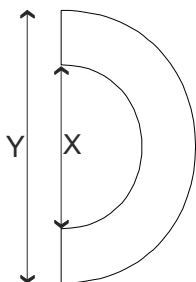

KOLUMNY

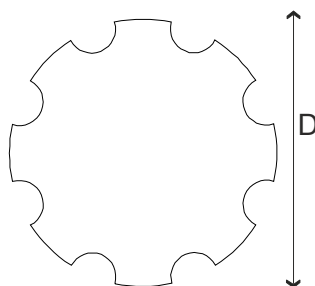

RUSTYKI

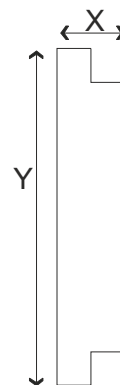

GŁOWICE I BAZY

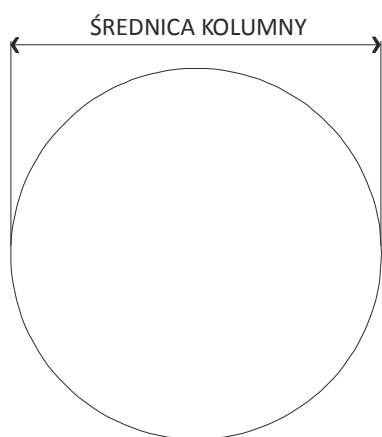
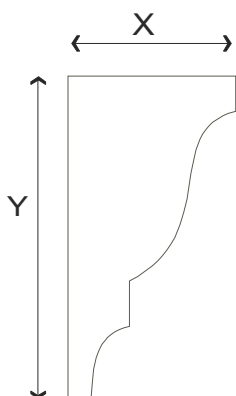

ZWORNIKI

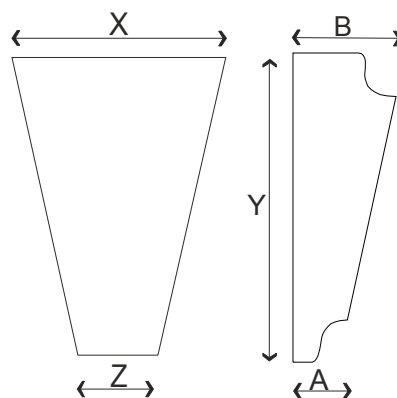

PODPARAPETNIKI

